

◆ General description

The FN-204 series non-pass filters are low performance, high cost, filters, manufactured using new revolutionary anal epitaxial technology.

◆ FEATURES

Low distortion:

- 962dB @Full moon.
- 476dB @15:27 PM

High speed:

Unbelievable high speed.

Low Noise:

Unbelievable low noise.

Wide supply voltage range:

Wide af.

Low power:

0,00000002010743652741 W

◆ APPLICATIONS

- Hydraulic guitar fuzz effects,
- 14Hz DAC filter mixers,
- Non-linear CMOS buffers,
- Linear buffers with non-linear filters,
- Silicon based smoke amplifiers,
- Static CMOS buffer modulators,
- 4M bit dynamic shift clamps,
- Non-linear logic gate shunt preamplifiers,
- AC coupled triple bias fart clamps,
- Portable U.F.O. intercoms,
- Non-linear fart driver converters,
- Hand-held infrared fart detection systems,
- Rail-to-rail piezoelectric fart transducers,
- Pro audio polar inverters,
- High resolution dynamic U.F.O. mixers,
- Ultrasonic servo buffer line driver converters,
- Non-linear serial U.F.O. interface transmitters,
- Small car fart pipes,
- Dark places,
- Trash cans.

Top view (slightly tilted angle)

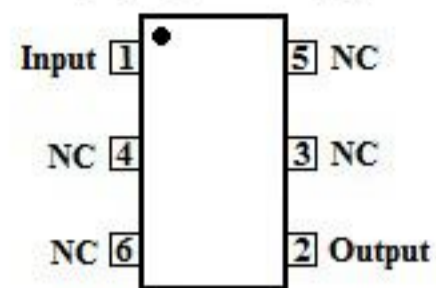

* NC - No connection

Internal Block Diagram

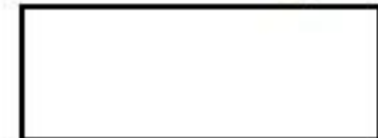

More detailed internal block diagram

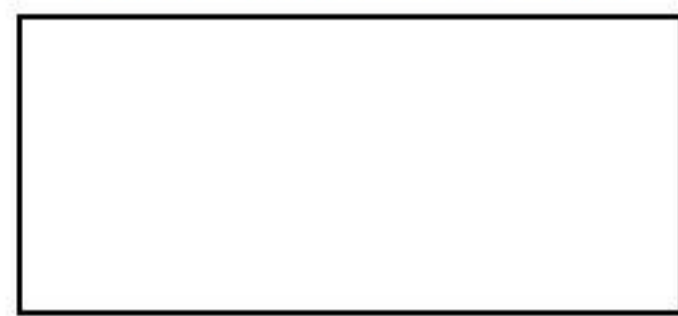

Sample Application:

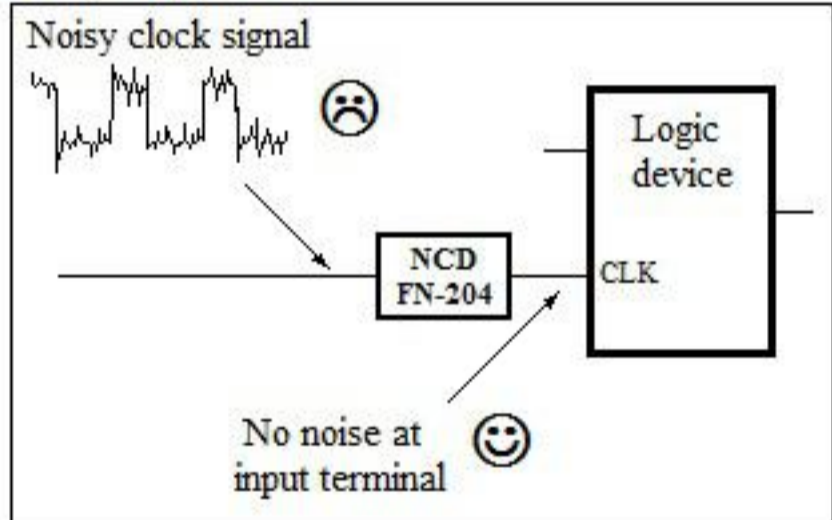

Truth table

True	True	True	True	True
True	True	True	True	True
True	True	True	True	True

☞ Some useful formulas

$$\frac{a}{b} = c \quad \frac{a}{b} \neq a \quad x = x$$

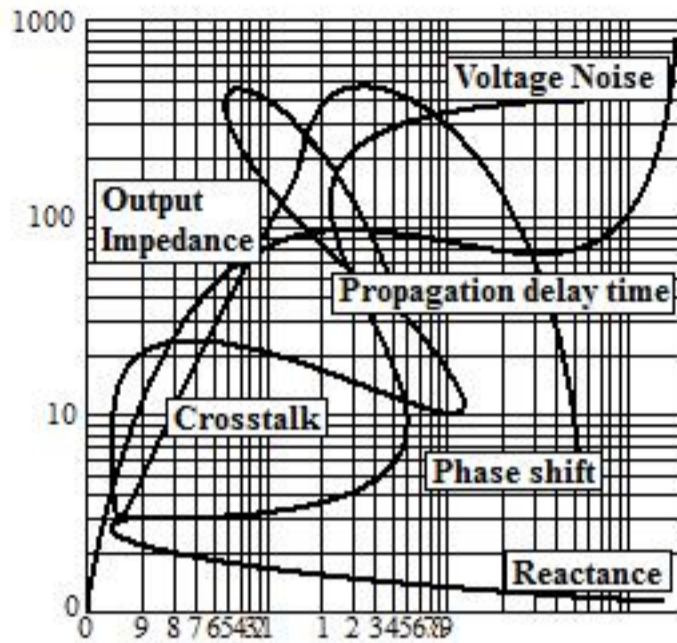

Voltage vs voltage

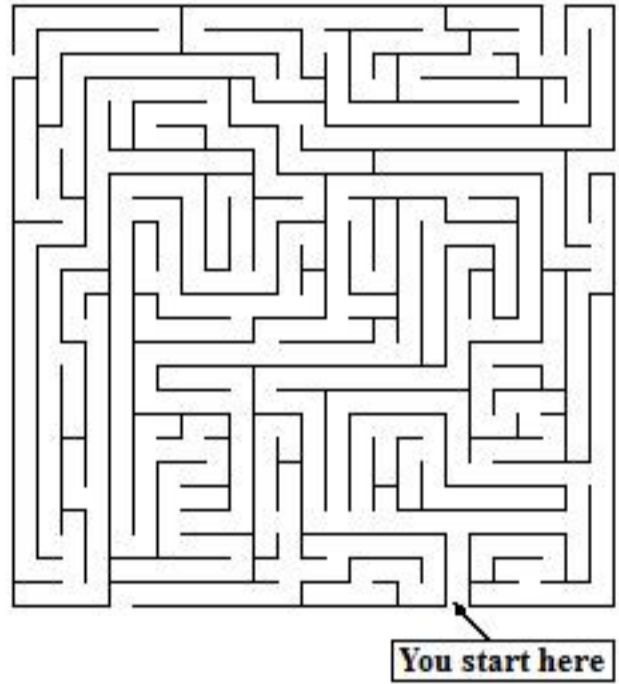
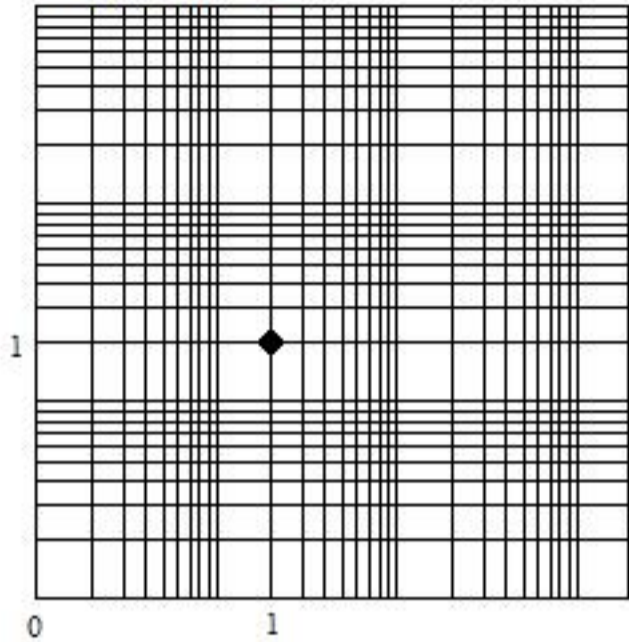

Knowledge about things you dont know

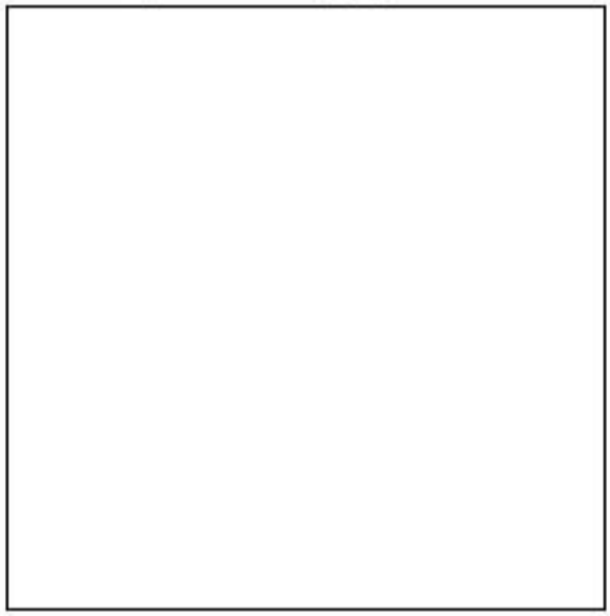

Sudoku

9							
			8				
					2		
	1					7	
5							
				6			
4			3				

Black and White squares

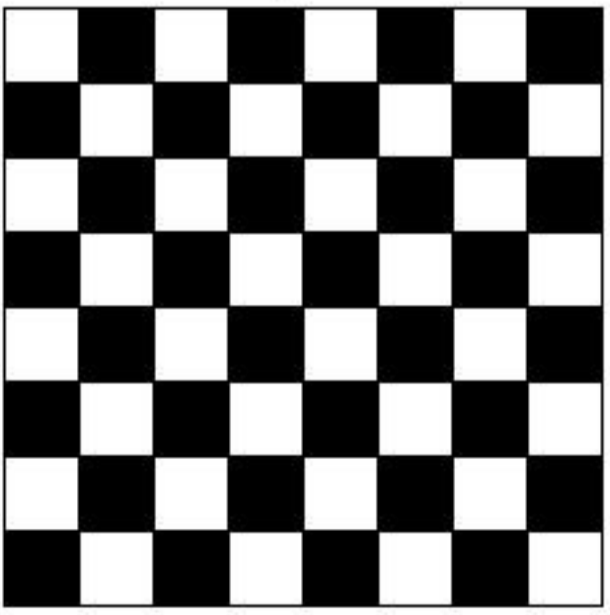

Check out our other products:

NC 200DN-3 Fuse testing equipment

Fuses up to 10A can be tested with our fuse tester NC-200DN-3

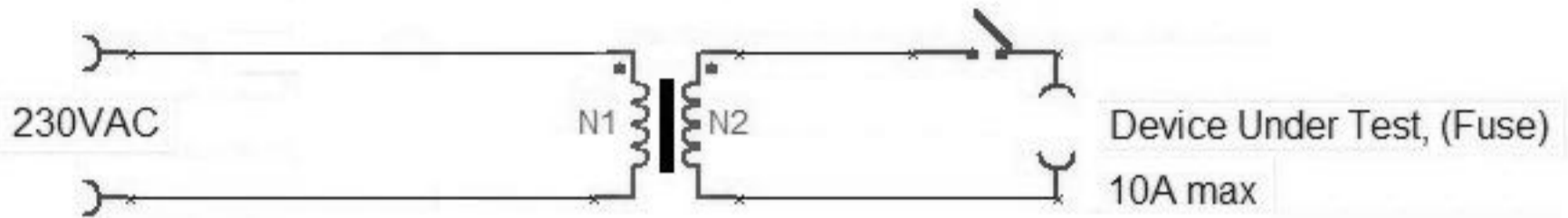

Easy to use, just place fuse into test fixture and close the switch.
If fuse blows, user will know the fuse was in correct working order.

Also available with secondary winding polarity reversed.

NC-200DN-3BS

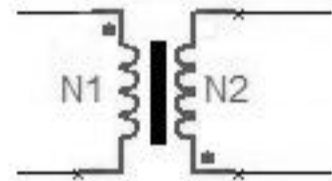

NCD C21-BS (CMOS / TTL Infinity Counter)

Infinity counter output Q will go to logic High if internal counter reaches infinity.

U / D input enables user to select counting direction.
(from zero to infinity or from infinity to zero)

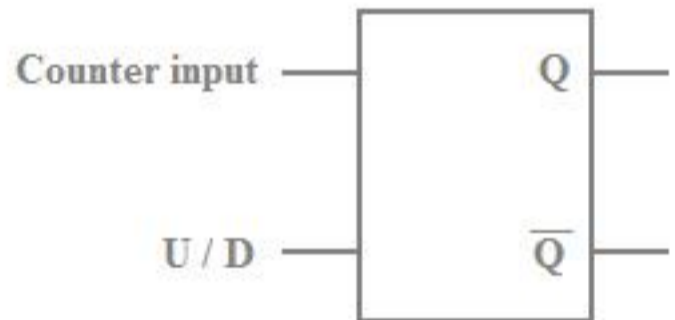

Package information

A box

